

# STT27

## Thyristor-Thyristor Modules

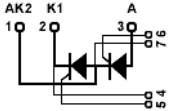
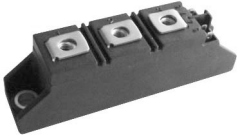

Type	$V_{RSM}$	$V_{RRM}$
	$V_{DSM}$	$V_{DRM}$
	V	V
STT27GK08	900	800
STT27GK12	1300	1200
STT27GK14	1500	1400
STT27GK16	1700	1600
STT27GK18	1900	1800

Dimensions in mm (1mm=0.0394")

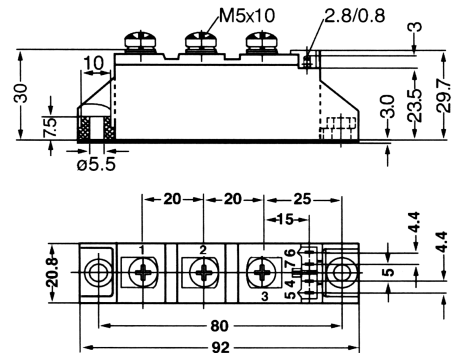

Symbol	Test Conditions	Maximum Ratings	Unit	
$I_{TRMS}, I_{FRMS}$ $I_{TAVM}, I_{FAVM}$	$T_{VJ}=T_{VJM}$ $T_C=85^{\circ}C; 180^{\circ}$ sine	50 27	A	
$I_{TSM}, I_{FSM}$	$T_{VJ}=45^{\circ}C$ $V_R=0$ $t=10ms$ (50Hz), sine $t=8.3ms$ (60Hz), sine	520 560	A	
	$T_{VJ}=T_{VJM}$ $V_R=0$ $t=10ms$ (50Hz), sine $t=8.3ms$ (60Hz), sine	460 500		
$\int i^2 dt$	$T_{VJ}=45^{\circ}C$ $V_R=0$ $t=10ms$ (50Hz), sine $t=8.3ms$ (60Hz), sine	1350 1300	A <sup>2</sup> s	
	$T_{VJ}=T_{VJM}$ $V_R=0$ $t=10ms$ (50Hz), sine $t=8.3ms$ (60Hz), sine	1050 1030		
$(di/dt)_{cr}$	$T_{VJ}=T_{VJM}$ $f=50Hz, t_p=200\mu s$ $V_D=2/3V_{DRM}$ $I_G=0.45A$ $di_G/dt=0.45A/\mu s$	repetitive, $I_T=45A$    non repetitive, $I_T=I_{TAVM}$	150    500	A/ $\mu s$
	$T_{VJ}=T_{VJM};$ $R_{GK}=\infty;$ method 1 (linear voltage rise)	$V_{DR}=2/3V_{DRM}$	1000	
$P_{GM}$	$T_{VJ}=T_{VJM}$ $I_T=I_{TAVM}$	$t_p=30\mu s$ $t_p=300\mu s$	10 5	W
$P_{GAV}$			0.5	W
$V_{RGM}$			10	V
$T_{VJ}$ $T_{VJM}$ $T_{stg}$			-40...+125 125 -40...+125	$^{\circ}C$
$V_{ISOL}$	50/60Hz, RMS $I_{ISOL} \leq 1mA$	$t=1min$ $t=1s$	3000 3600	V~
$M_d$	Mounting torque (M5) Terminal connection torque (M5)		2.5-4.0/22-35 2.5-4.0/22-35	Nm/lb.in.
Weight	Typical including screws		90	g

# STT27

## Thyristor-Thyristor Modules

Symbol	Test Conditions	Characteristic Values	Unit
$I_{RRM}, I_{DRM}$	$T_{VJ}=T_{VJM}; V_R=V_{RRM}; V_D=V_{DRM}$	3	mA
$V_T, V_F$	$I_T, I_F=80A; T_{VJ}=25^{\circ}C$	1.64	V
$V_{TO}$	For power-loss calculations only ( $T_{VJ}=125^{\circ}C$ )	0.85	V
$r_T$		11	$m\Omega$
$V_{GT}$	$V_D=6V;$ $T_{VJ}=25^{\circ}C$ $T_{VJ}=-40^{\circ}C$	1.5 1.6	V
$I_{GT}$	$V_D=6V;$ $T_{VJ}=25^{\circ}C$ $T_{VJ}=-40^{\circ}C$	100 200	mA
$V_{GD}$	$T_{VJ}=T_{VJM};$ $V_D=2/3V_{DRM}$	0.2	V
$I_{GD}$		10	mA
$I_L$	$T_{VJ}=25^{\circ}C; t_p=10\mu s; V_D=6V$ $I_G=0.45A; di_G/dt=0.45A/\mu s$	450	mA
$I_H$	$T_{VJ}=25^{\circ}C; V_D=6V; R_{GK}=\infty$	200	mA
$t_{gd}$	$T_{VJ}=25^{\circ}C; V_D=1/2V_{DRM}$ $I_G=0.45A; di_G/dt=0.45A/\mu s$	2	$\mu s$
$t_q$	$T_{VJ}=T_{VJM}; I_T=20A; t_p=200\mu s; -di/dt=10A/\mu s$ $V_R=100V; dv/dt=20V/\mu s; V_D=2/3V_{DRM}$	150	$\mu s$
$Q_S$	$T_{VJ}=T_{VJM}; I_T, I_F=25A; -di/dt=0.64A/\mu s$	50	$\mu C$
$I_{RM}$		6	A
$R_{thJC}$	per thyristor/diode; DC current per module	0.88 0.44	K/W
$R_{thJK}$	per thyristor/diode; DC current per module	1.08 0.54	K/W
$d_s$	Creeping distance on surface	12.7	mm
$d_A$	Strike distance through air	9.6	mm
$a$	Maximum allowable acceleration	50	$m/s^2$

### FEATURES

- \* International standard package
- \* Copper base plate
- \* Planar passivated chips
- \* Isolation voltage 3600 V~

### APPLICATIONS

- \* DC motor control
- \* Softstart AC motor controller
- \* Light, heat and temperature control

### ADVANTAGES

- \* Space and weight savings
- \* Simple mounting with two screws
- \* Improved temperature and power cycling
- \* Reduced protection circuits

# STT27

## Thyristor-Thyristor Modules

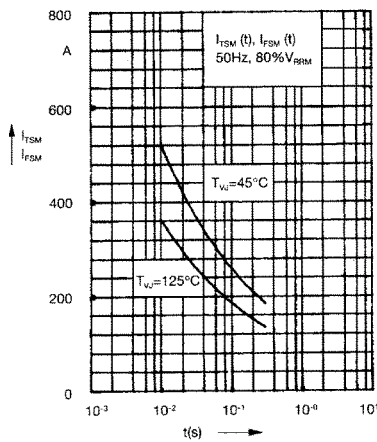

Fig. 1 Surge overload current  
 $I_{TSM}$ ,  $I_{FSM}$ : Crest value, t: duration

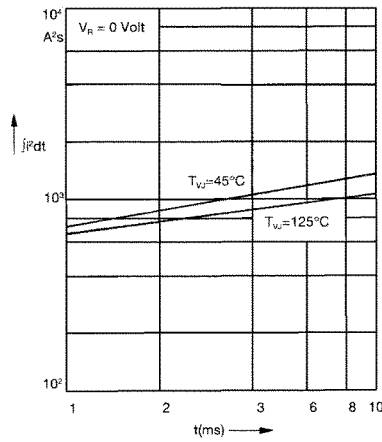

Fig. 2  $\int i^2 dt$  versus time (1-10 ms)

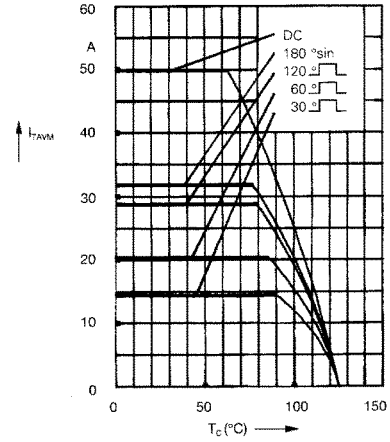

Fig. 2a Maximum forward current at case temperature

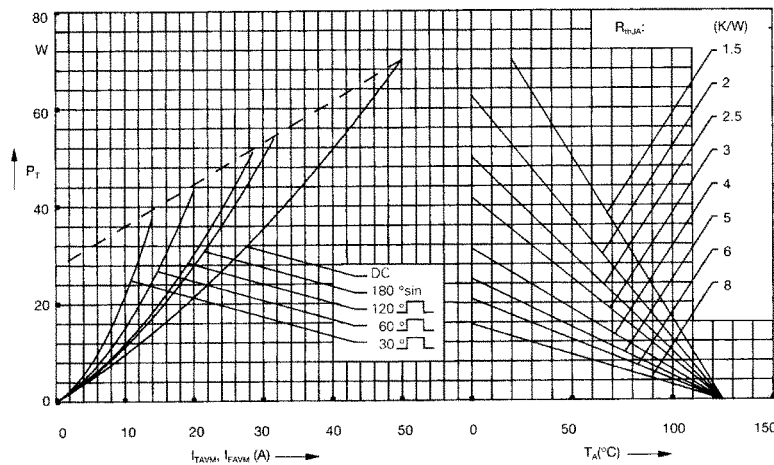

Fig. 3 Power dissipation versus on-state current and ambient temperature (per thyristor or diode)

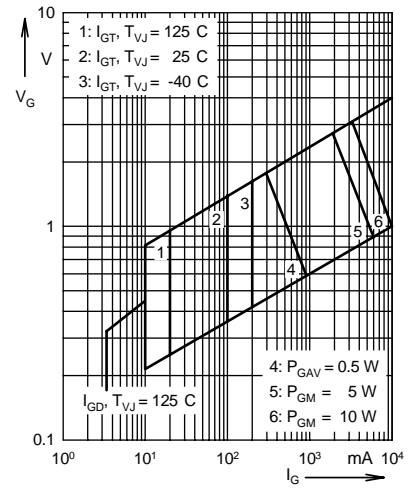

Fig. 4 Gate trigger characteristics

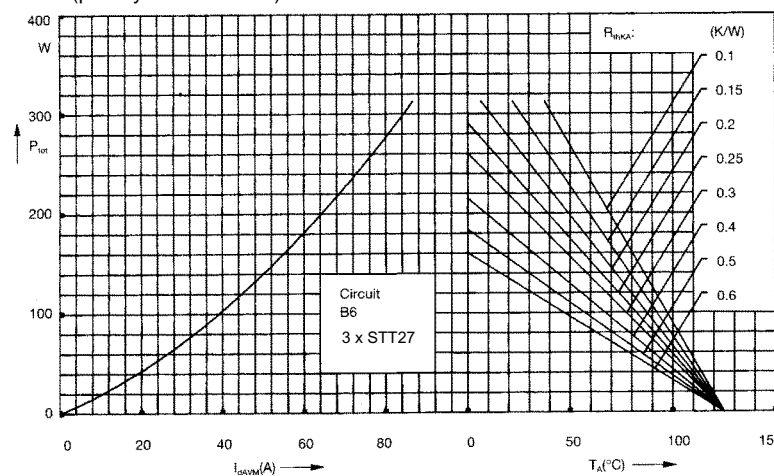

Fig. 5 Three phase rectifier bridge: Power dissipation versus direct output current and ambient temperature

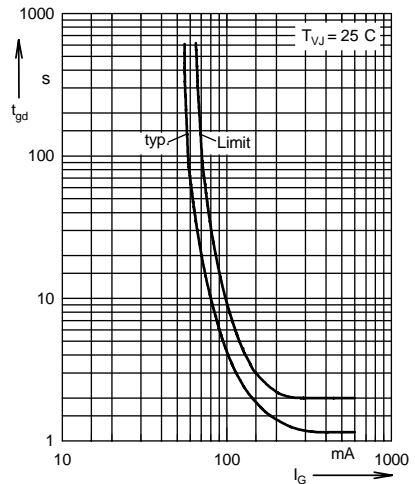

Fig. 6 Gate trigger delay time

# STT27

## Thyristor-Thyristor Modules

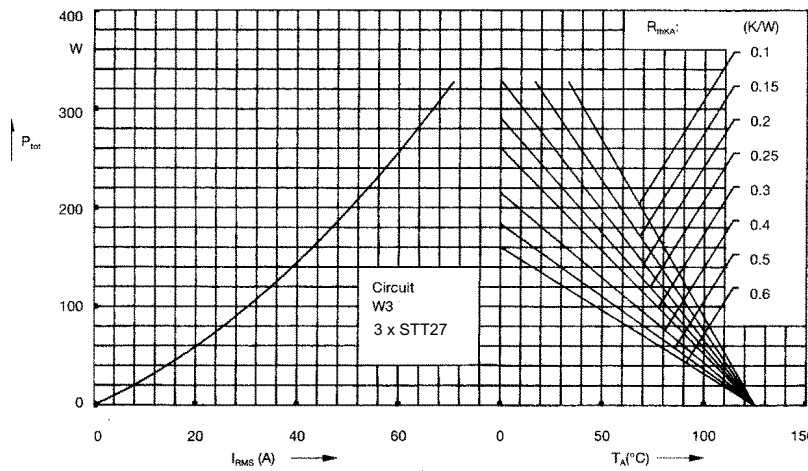

Fig. 7 Three phase AC-controller: Power dissipation versus RMS output current and ambient temperature

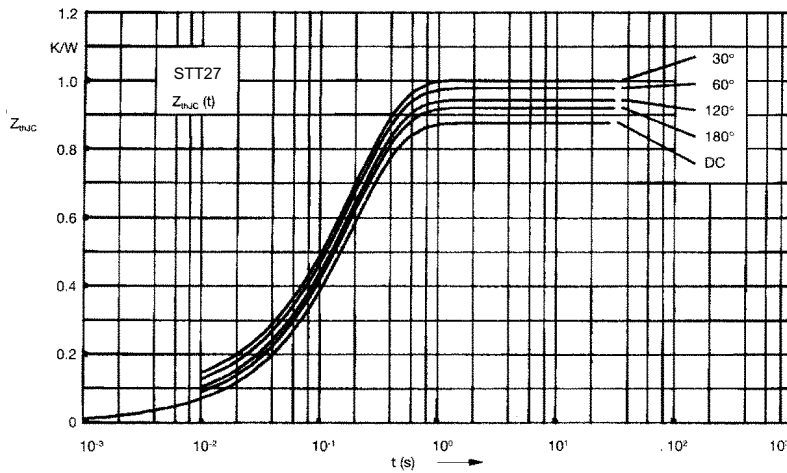

Fig. 8 Transient thermal impedance junction to case (per thyristor or diode)

$R_{thJC}$  for various conduction angles d:

d	$R_{thJC}$ (K/W)
DC	0.88
180°C	0.92
120°C	0.95
60°C	0.98
30°C	1.01

Constants for  $Z_{thJC}$  calculation:

i	$R_{thi}$ (K/W)	$t_i$ (s)
1	0.019	0.0031
2	0.029	0.0216
3	0.832	0.191

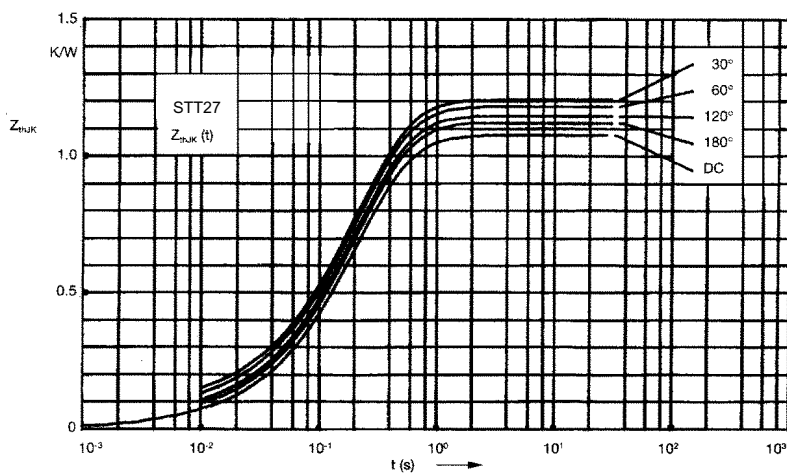

Fig. 9 Transient thermal impedance junction to heatsink (per thyristor or diode)

$R_{thJK}$  for various conduction angles d:

d	$R_{thJK}$ (K/W)
DC	1.08
180°C	1.12
120°C	1.15
60°C	1.18
30°C	1.21

Constants for  $Z_{thJK}$  calculation:

i	$R_{thi}$ (K/W)	$t_i$ (s)
1	0.019	0.0031
2	0.029	0.0216
3	0.832	0.191
4	0.2	0.45